

N4985A System Amplifiers



N4985A-P15
10 MHz to 50 GHz



N4985A-P25
2 to 50 GHz



N4985A-S30
100 kHz to 30 GHz



N4985A-S50
100 kHz to 50 GHz

Exceptional Gain and Power Performance Over A Broad Bandwidth

- Bench-top lab work
- Production line testing
- Saturated RF amplifier testing
- Drive TWT amplifiers
- Antenna system amplification

N4985A-P15

High Performance 10 MHz to 50 GHz System Amplifier



Features

- 1 W (30 dBm) P_{sat} 2 to 10 GHz
- Excellent performance at 20 GHz:
- High gain (25 dB, +2 dB flatness)
- 26 dBm P_{-1dB} , 29 dBm P_{sat}
- Easy to integrate into your lab:
- Built-in cooling fan
- AC power supply
- Size: 5.5 x 4.5 x 2.75 inch

Description

The N4985A-P15 system amplifier is a high performance broadband amplifier with excellent power and gain from 10 MHz to 50 GHz. The amplifier is designed to be easily used in lab and test applications and is completely self-contained with a standard AC power supply.

Applications

The N4985A-P15 is a test amplifier designed for broadband power and gain applications. It is ideally suited for saturated RF amplifier testing, driving TWT amplifiers, or as an antenna system amplifier. High gain and typically 22 dBm output power at 50 GHz will overcome long cable losses from the signal source, and will provide additional power required in many development and test applications.

Specifications at 25 °C

Parameter	Description	10 MHz to 2 GHz			2 to 10 GHz			10 to 30 GHz			30 to 40 GHz			40 to 50 GHz		
		Min	Typ	Max	Min	Typ	Max	Min	Typ	Max	Min	Typ	Max	Min	Typ	Max
P_{sat} (dBm)	Saturated output power	20	24	-	26	30	-	25	29	-	23	27	-	20	24	-
P-1 (dBm)	1 dB compressed power	17	22	-	24	28	-	23	27	-	21	25	-	17	22	-
S21 (dB)	Small signal gain	20	25	-	25	29	-	24	28	-	21	25	-	17	24	-
S11 (dB)	Input match	-	-15	-	-	-15	-	-	-15	-	-	-10	-	-	-8	-
S22 (dB)	Output match	-	-6	-	-	-15	-	-	-10	-	-	-6	-	-	-6	-
S12 (dB)	Reverse isolation	-	-60	-	-	-60	-	-	-60	-	-	-50	-	-	-50	-
NF (dBm)	Noise figure	-	-	-	-	9	-	-	9	-	-	10.5	-	-	12	-
H2 (dBc)	2nd harmonic at P-1	-	-40	-	-	-40	-	-	-40	-	-	-35	-	-	-30	-
H3 (dBc)	3rd harmonic at P-1	-	-20	-	-	-20	-	-	-20	-	-	-	-	-	-	-

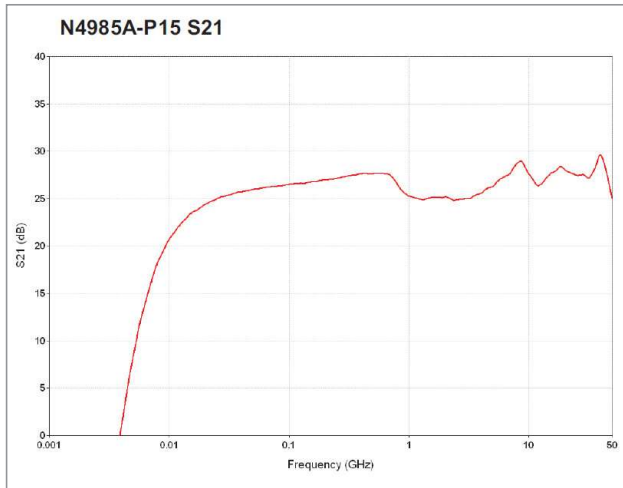

Figure 1. S21

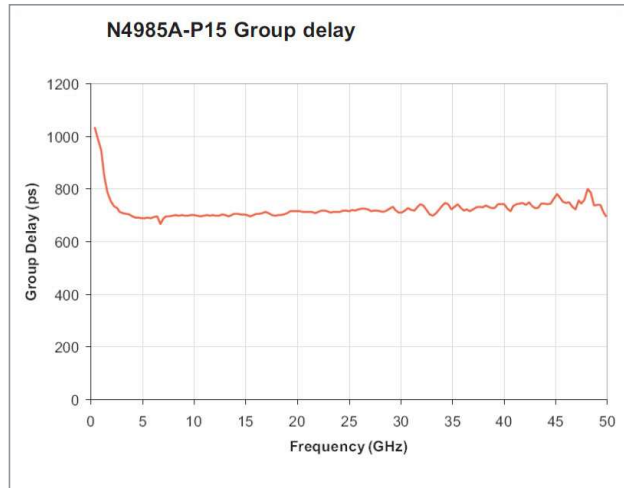

Figure 2. Group delay

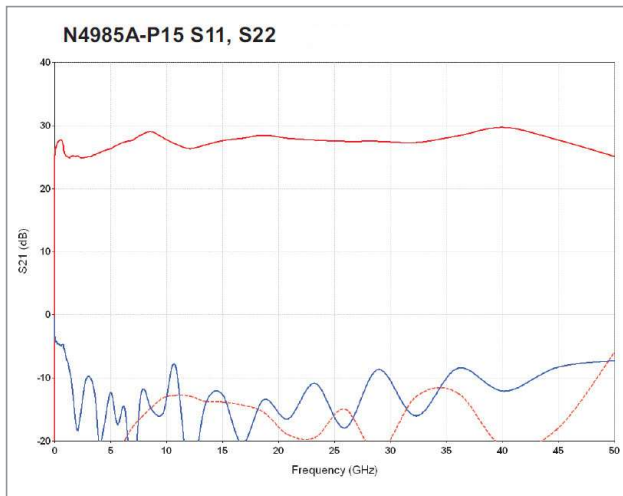

Figure 3. S11, S22

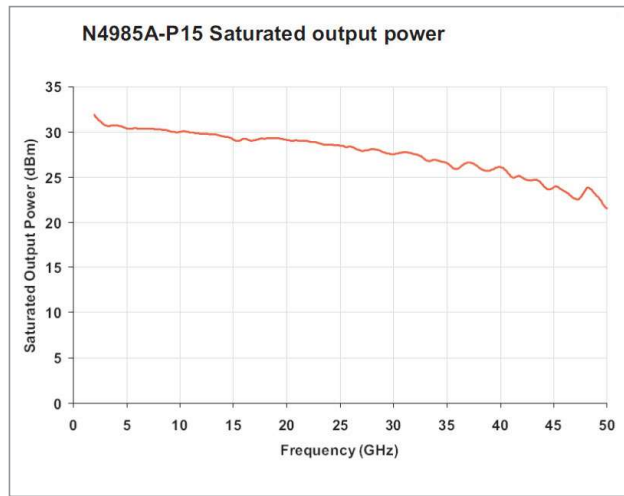

Figure 4. Saturated output power

Supplemental Data

Description	
Operating temperature	0 to 55 °C
Pin max	26 dBm
DC power dissipation	9 V; 1.5 A
Input connector	2.4 mm
Output connector	2.4 mm

N4985A-P25

High Performance 2 to 50 GHz System Amplifier

Features

- 1 W (30 dBm) P_{sat} to 10 GHz
- Excellent performance at 20 GHz:
 - High gain (27 dB, +2 dB flatness)
- 26 dBm $P_{-1\text{ dB}}$, 29 dBm P_{sat}
- Easy to integrate into your lab:
 - Built-in cooling fan
 - AC power supply
- Size: 5.5 x 4.5 x 2.75 inch



Description

The N4985A-P25 system amplifier is a high performance broadband amplifier with excellent power and gain from 2 to 50 GHz. The amplifier is designed to be easily used in lab and test applications and is completely self-contained with a standard AC power supply.

Applications

The N4985A-P25 is a test amplifier designed for broadband power and gain applications. It is ideally suited for saturated RF amplifier testing, driving TWT amplifiers, or as an antenna system amplifier. High gain and typically 22 dBm output power at 50 GHz will overcome long cable losses from the signal source, and will provide additional power required in many development and test applications.

Specifications at 25 °C

Parameter	Description	2 to 10 GHz			10 to 30 GHz			30 to 40 GHz			40 to 50 GHz		
		Min	Typ	Max	Min	Typ	Max	Min	Typ	Max	Min	Typ	Max
P_{sat} (dBm)	Saturated output power	26	30	-	25	29	-	23	27	-	20	24	-
P-1 (dBm)	1 dB compressed power	24	28	-	23	27	-	21	25	-	17	22	-
S21 (dB)	Small signal gain	25	29	-	24	28	-	21	25	-	17	24	-
S11 (dB)	Input match	-	-15	-	-	-15	-	-	-10	-	-	-8	-
S22 (dB)	Output match	-	-15	-	-	-10	-	-	-6	-	-	-6	-
S12 (dB)	Reverse isolation	-	-60	-	-	-60	-	-	-50	-	-	-50	-
NF (dBm)	Noise figure	-	9	-	-	9	-	-	10.5	-	-	12	-
H2 (dBc)	2nd harmonic at P-1	-	-40	-	-	-40	-	-	-3.5	-	-	-30	-
H3 (dBc)	3rd harmonic at P-1	-	-20	-	-	-20	-	-	-	-	-	-	-

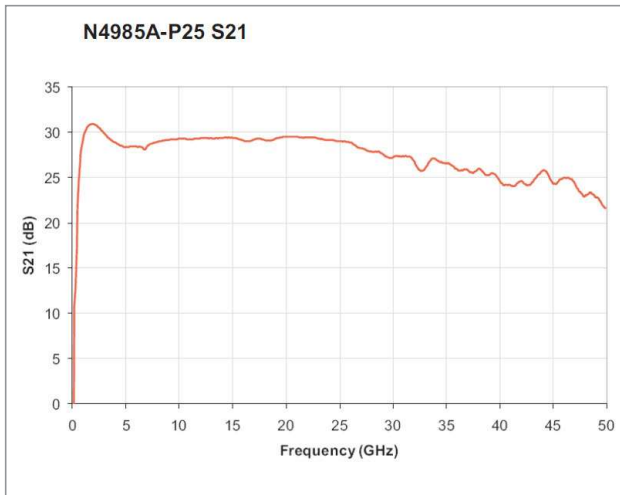

Figure 5. N4985A-P25 S21

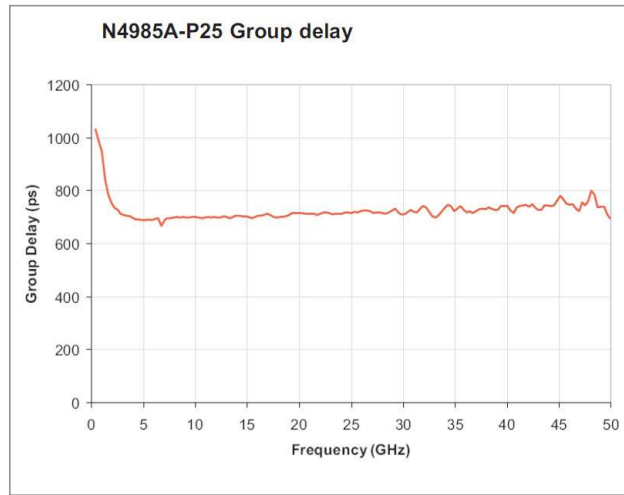

Figure 6. N4985A-P25 group delay

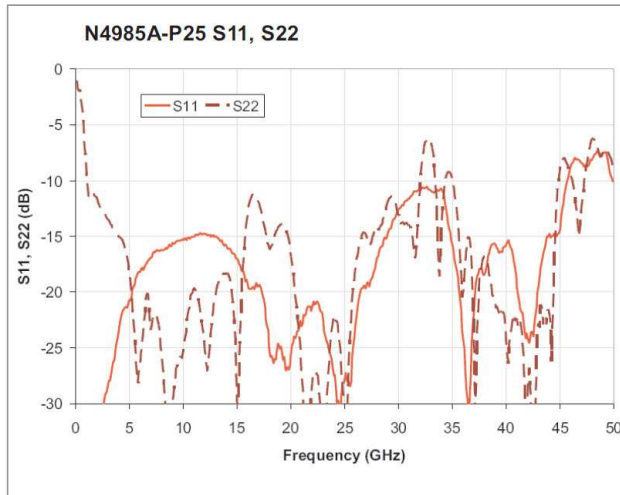

Figure 7. N4985A-P25 S11, S22

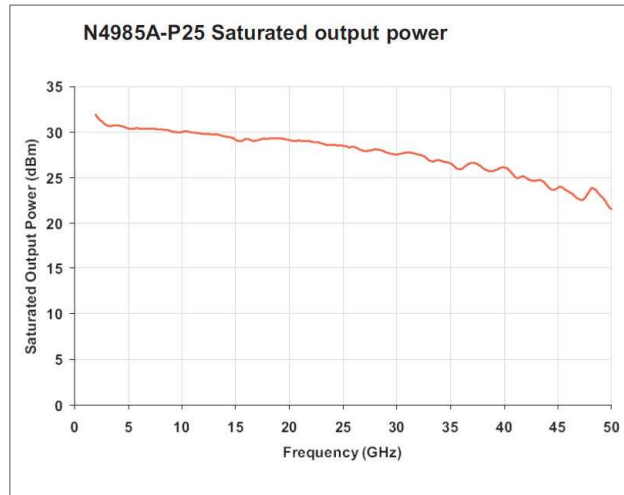

Figure 8. N4985A-P25 saturated output power

Supplemental Data

Description	
Operating temperature	0 to 55 °C
Pin max	26 dBm
DC power dissipation	9 V; 1.5 A
Input connector	2.4 mm
Output connector	2.4 mm

N4985A-S30

100 kHz to 30 GHz Broadband RF Amplifier

Features

- Broadband: 100 kHz to 30 GHz
- 22 dBm P_{sat} at 26 GHz
- 30 dB gain to 26 GHz
- Useful gain above 30 GHz
- < 5 dB noise figure
- AC power supply included
- Small size: 3.5" x 3.5" x 1"



Description

The N4985A-S30 system amplifier is a high performance, broadband amplifier featuring baseband RF (< 100 kHz) through millimeter wave (> 30 GHz) frequency coverage. The amplifier is designed to be a multi-use laboratory RF amplifier as a gain block for frequency domain applications or as a time domain pulse amplifier. It's small size and versatile performance make it an excellent selection as a general purpose gain block with moderate power output in a single package potentially replacing 2 or 3 narrower band amplifiers.

Applications

The N4985A-S30 system amplifier is an often needed companion to synthesized signal generators and microwave sources. The amplifier's small size allows close placement to the DUT or test fixture. High gain and greater than 20 dBm output power will overcome long cable losses from the signal source and provide the additional output power needed in many development and test applications.

Specifications at 25°C

Parameter	Description	Minimum	Typical	Maximum
S21 (dB)	Small signal gain 1 to 26 GHz	27	30	-
S11/S22 (dB)	Input/output return loss 1 to 26 GHz	-	-10	-
P_{sat} (dBm)	Saturated output power 100 kHz to 26 GHz	+20	+22	-
NF (dB)	Noise figure 2 to 30 GHz	-	5	-
H2 (dBc)	2nd harmonic 2 to 25 GHz	-	-30	-

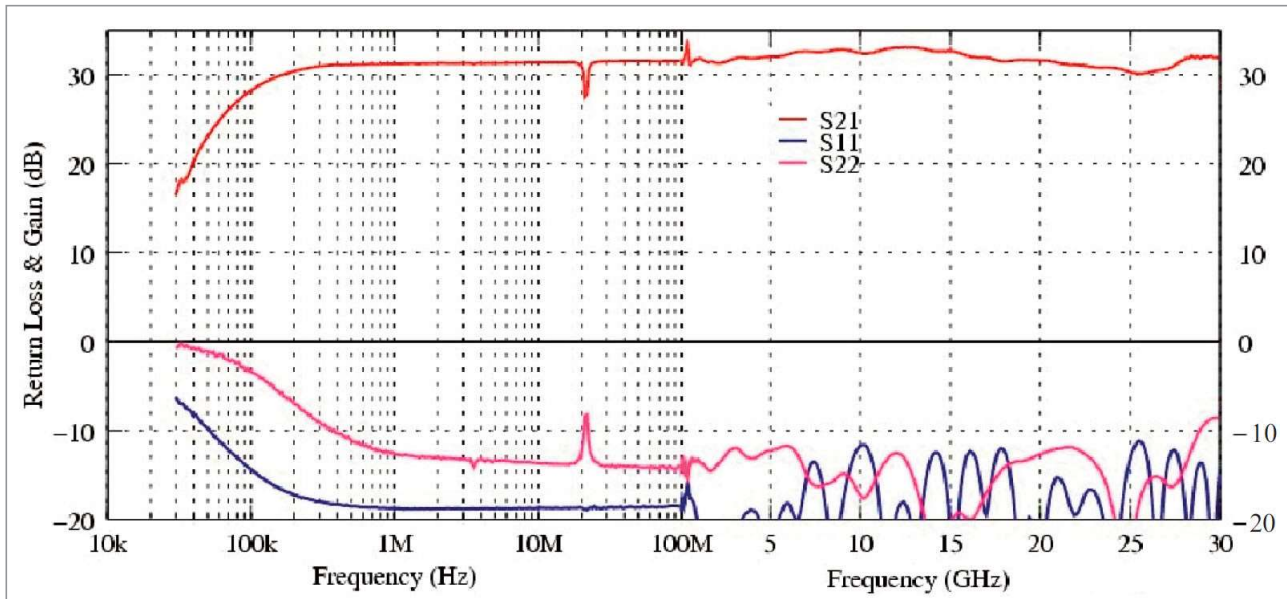

Figure 9. Small signal parameters vs. frequency

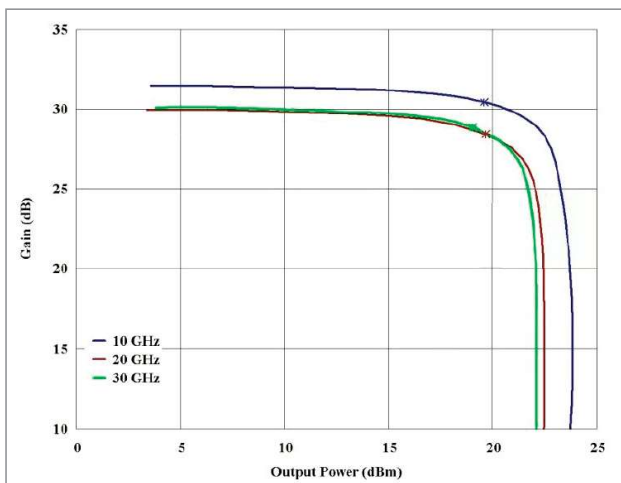

Figure 10. Gain vs. output power (P1 dB indicated with *)

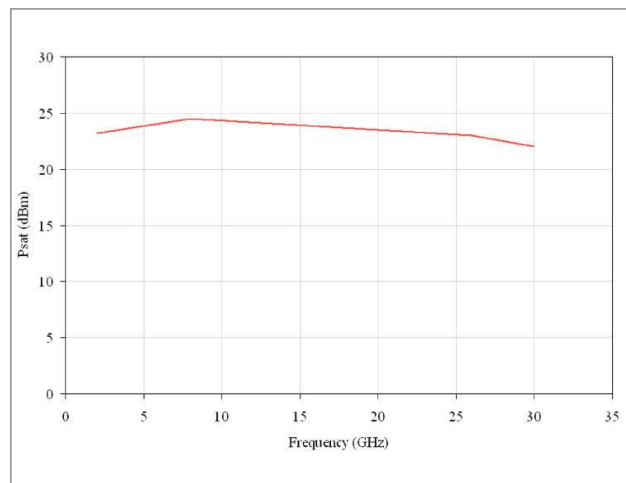

Figure 11. Saturated output power

Supplemental Data

Description	
Operating temperature	0 to 55 °C
Pin max	20 dBm
DC power dissipation	9 V; 500 mA
Input/output connectors	2.92 mm, Female

N4985A-OA3 – Optical Application Tuning

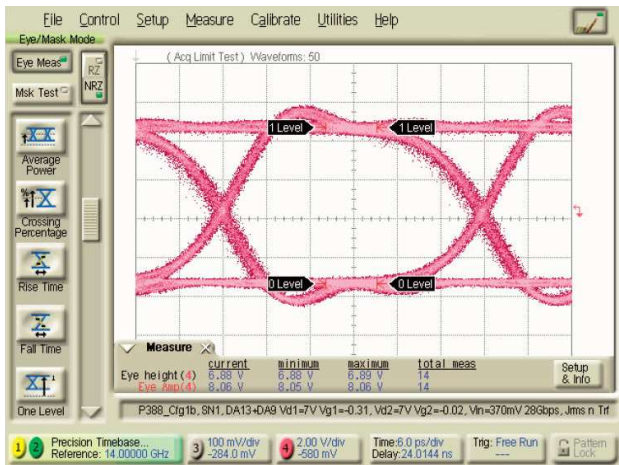

Figure 12. **N4985A-OA3 (2³¹-1)**
EYE: > 7 V output (1.5 V/div)

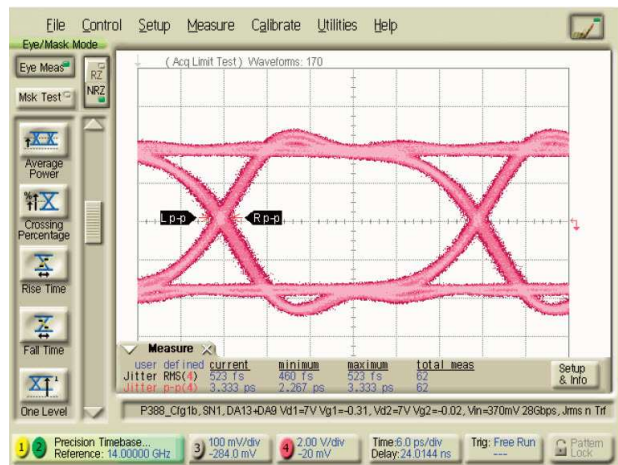

Figure 13. **N4985A-OA3 (2³¹-1)**
EYE: < 500 fs added rms jitter (5 ps/div)

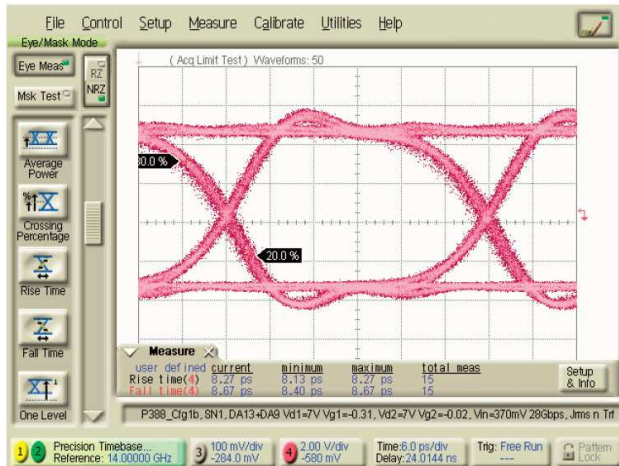

Figure 14. **N4985A-OA3 (2³¹-1)**
EYE: < 10 ps Tf/Tf (5 ps/div)

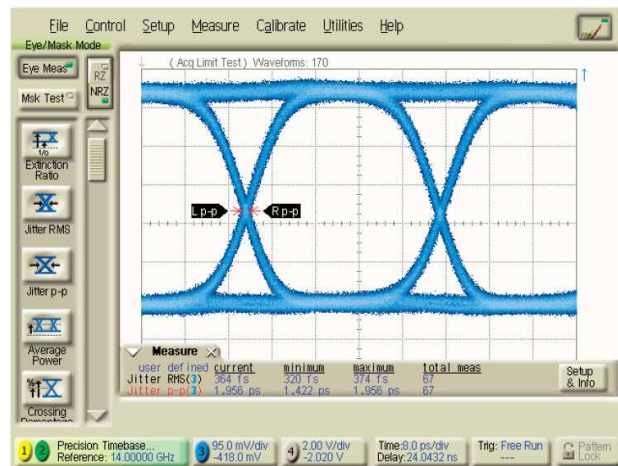

Figure 15. **N4985A-OA3 (2³¹-1)**
EYE: Input signal from PRBS generator

Additional Specifications for N4985A-OA3

Parameter	Description	Minimum	Typical	Maximum
S21 (V)	Output eye amplitude	7	7.5	–
	Input eye amplitude	–	0.5	–
S21 (ps)	Jitter additive (rms)	–	< 0.5	< 1
Tr/Tf (ps)	Rise/fall time	–	< 8	< 10

N4985A-S50

100 kHz to 50 GHz Broadband RF Amplifier

Features

- Broadband: 100 kHz to 50 GHz
- > 20 dBm P_{sat} at 40 GHz
- > 27 dB gain to 45 GHz
- Useful gain to 65 GHz
- < 6 dB noise figure
- AC power supply included
- Small size: 3.5" x 3.5" x 1"



Description

The N4985A-S50 system amplifier is a high performance, broadband (over 18 octaves) amplifier featuring baseband RF (< 100 kHz) through millimeter wave (> 50 GHz) frequency coverage. The amplifier is designed to be a multi-use laboratory RF Amplifier as a gain block for frequency domain applications or as a time domain pulse amplifier. It's small size and versatile performance make it an excellent selection as a general purpose gain block with moderate power output in a single package potentially replacing 2 or 3 narrower band amplifiers.

Applications

The N4985A-S50 system amplifier is an often needed companion to synthesized signal generators and microwave sources. The amplifier's small size allows close placement to the DUT or test fixture. High gain and greater than 20 dBm output power will overcome long cable losses from the signal source and provide the additional output power needed in many development and test applications.

Specifications at 25°C

Parameter	Description	Minimum	Typical	Maximum
S21 (dB)	Small signal gain			
	1 to 26 GHz	27	30	-
	26 to 45 GHz	24	27	-
S11/S22 (dB)	Input/output return loss			
	1 to 26 GHz	-	-10	-
	26 to 45 GHz	-	-8	-
P_{sat} (dBm)	Saturated output power			
	100 kHz to 26 GHz	+20	+22	-
	40 GHz	-	+20	-
	50 GHz	-	+17	-
NF (dB)	Noise figure			
	2 to 30 GHz	-	5	-
	30 to 40 GHz	-	6	-
H2 (dBc)	2nd harmonic			
	2 to 25 GHz	-	-30	-

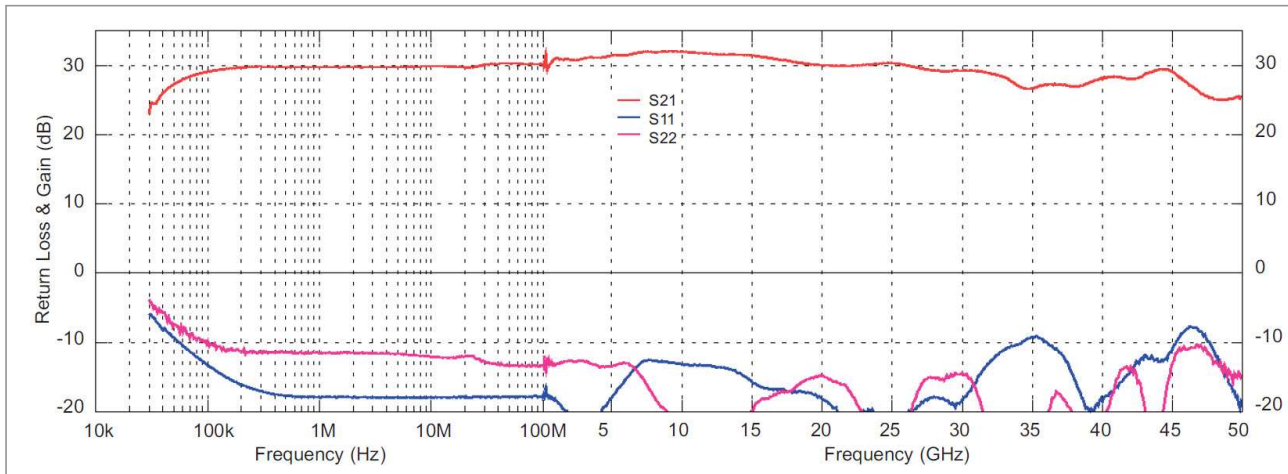

Figure 16. Small signal parameters vs. frequency

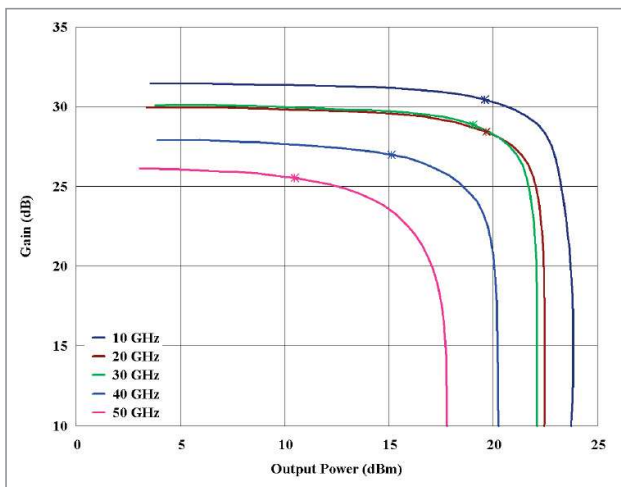

Figure 17. Gain vs. output power (P1 dB indicated with *)

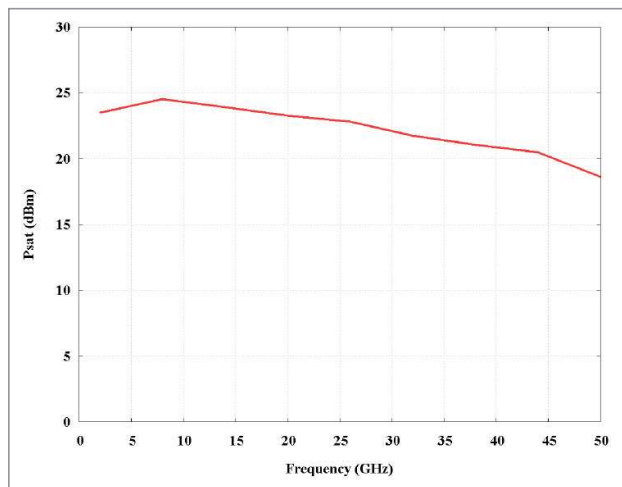

Figure 18. Saturated output power

Supplemental Data

Description	
Operating temperature	0 to 55 °C
Pin max	20 dBm
DC power dissipation	9 V; 500 mA
Input/output connectors	2.4 mm, Female

N4985A-OA5 – Optical Application Tuning

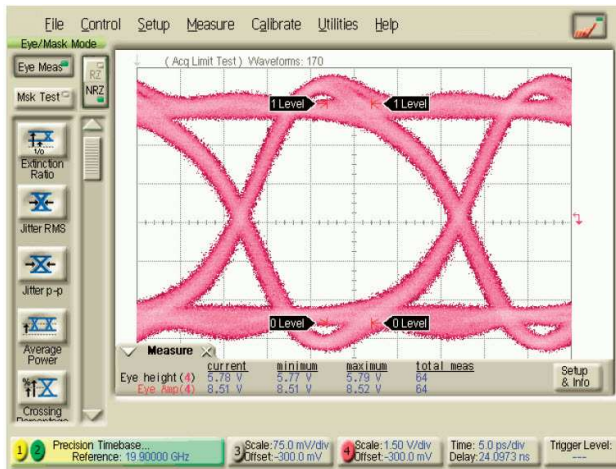

Figure 19. N4985A-OA5 (2³¹-1)
EYE: >7 V output (1.5 V/div)

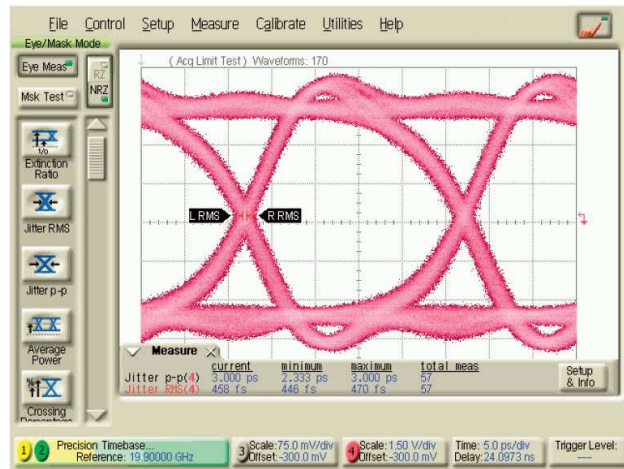

Figure 20. N4985A-OA5 (2³¹-1)
EYE: < 500 fs added rms jitter (5 ps/div)

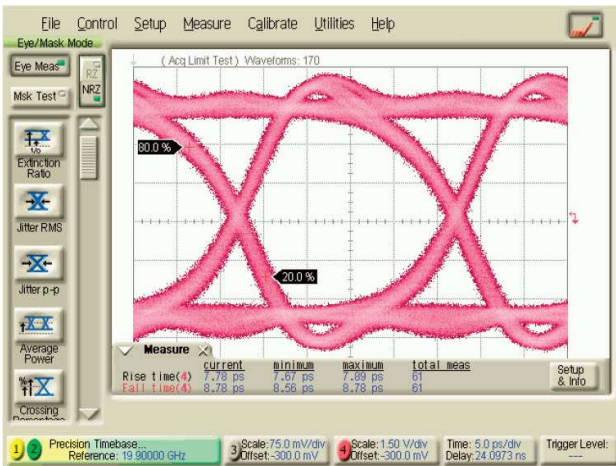

Figure 21. N4985A-OA5 (2³¹-1)
EYE: < 10 ps Tr/Tf (5 ps/div)

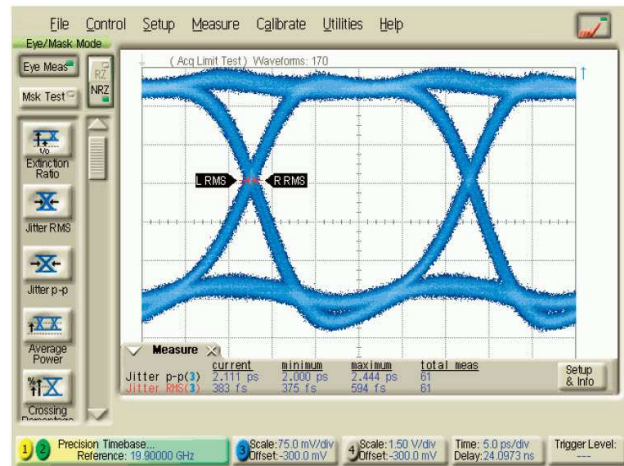

Figure 22. (2³¹ - 1)
EYE: Input signal from PRBS generator

Additional specifications for N4985A-OA5 are as follows:

Parameter	Description	Minimum	Typical	Maximum
S21 (V)	Output eye amplitude	7	7.5	-
	Input eye amplitude	-	0.5	-
S21 (ps)	Jitter additive (rms)	-	< 0.5	< 1
Tr/Tf (ps)	Rise/fall time	-	< 8	< 10

Regulatory Standards

Description	
EMC	
Complies with European EMC Directive 2004/108/EC	IEC/EN 61326-2-1
	CISPR Pub 11 Group 1, class A
	AS/NZS CISPR 11
	ICES/NMB-001
	This ISM device complies with Canadian ICES-001. Cet appareil ISM est conforme a la norme NMB-001 du Canada.

This is a sensitive measurement apparatus by design and may have some performance loss (sidebands up to -60 dBc, and loss of gain up to 18 dB) when exposed to ambient continuous electromagnetic phenomenon in the range of 80 MHz - 6 GHz when tested per IEC 61000-4-3.

Mechanical Dimension

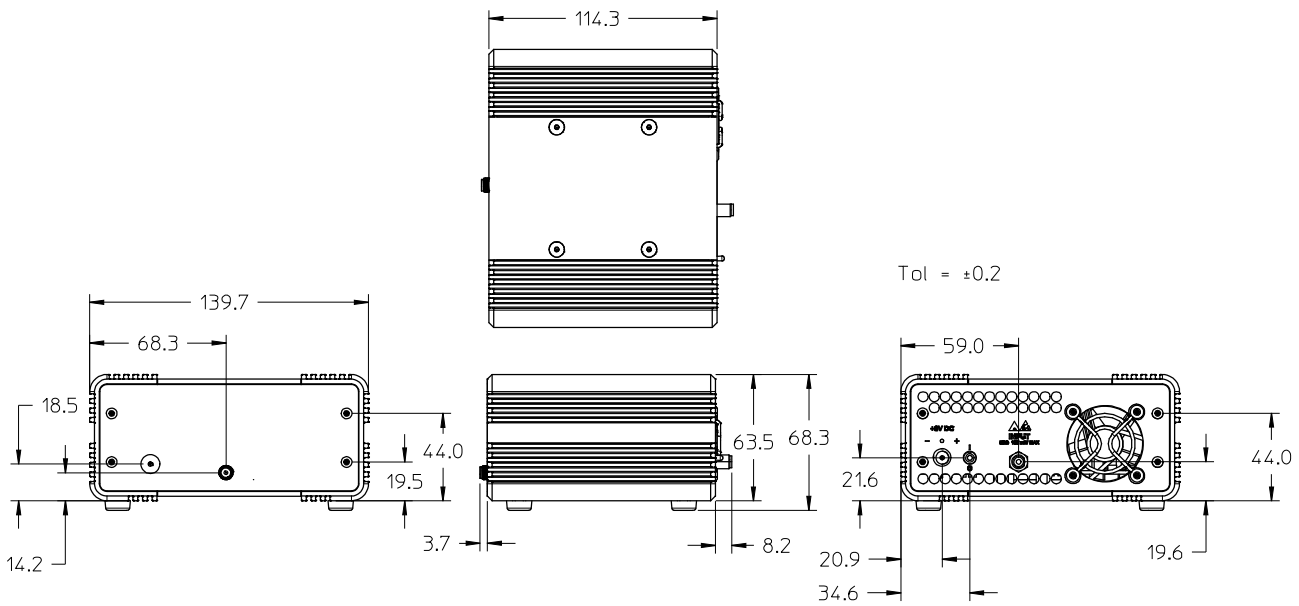

Figure 23. Mechanical dimension of N4985A-P15/P25

Mechanical Dimension

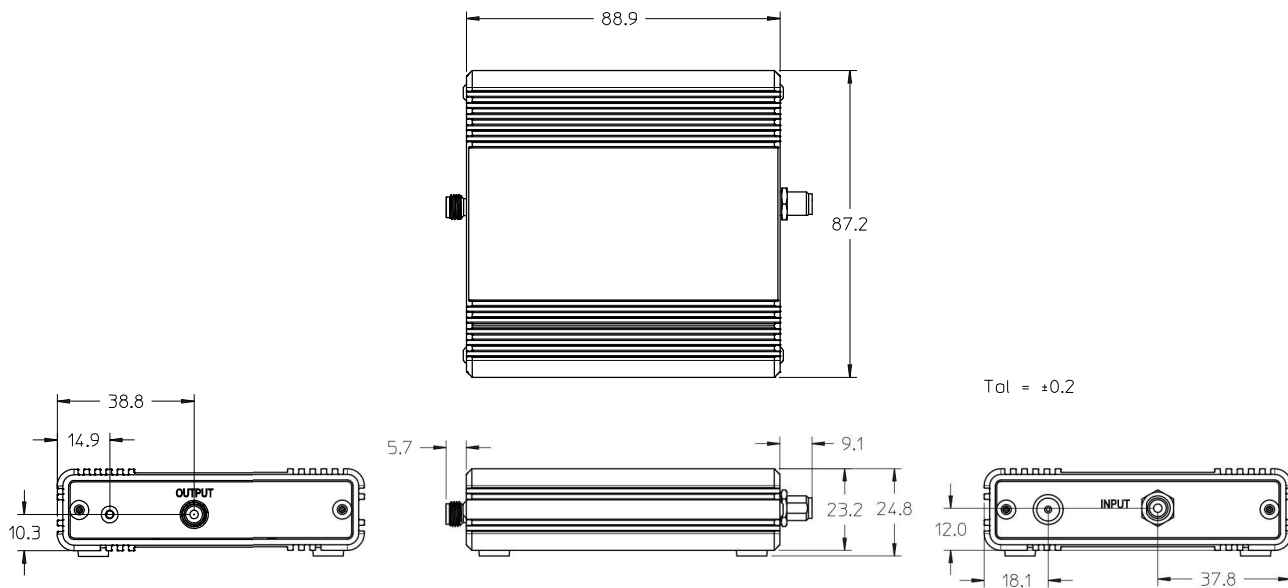

Figure 24. Mechanical dimension of N4985AS30/S50

Physical specifications for the N4985A amplifiers

Model	N4985A-S30	N4985A-S50	N4985A-P15	N4985A-P25
Net weight	0.26 kg	0.26 kg	1.03 kg	1.03 kg
Shipping weight	1.8 kg	1.8 kg	3.2 kg	3.2 kg
Shipping dimensions				
Length	90 mm	90 mm	114 mm	114 mm
Width	90 mm	90 mm	140 mm	140 mm
Height	25 mm	25 mm	70 mm	70 mm

www.keysight.com/find/N4985A

Learn more at: www.keysight.com

For more information on Keysight Technologies' products, applications or services, please contact your local Keysight office. The complete list is available at:

www.keysight.com/find/contactus

